



ADVANCED SURGICAL
PRODUCT CATALOG



ACCESS

SMOKE

ENERGY

INSTRUMENTS



ACCESS

- AirSeal[®] Intelligent Flow System**
- AirSeal[®] Tube Sets & Access Ports**
- BluView[™] Trocars (OUS Only)**
- Insufflation Needles & Accessories**



ACCESS

SMOKE

ENERGY

INSTRUMENTS

AirSeal® Intelligent Flow System



AirSeal® iFS

AirSeal iFS, 120V	AS-IFS1
AirSeal iFS, 230V	AS-IFS2

iFS Bottle Gas Connector (Required for bottle gas)

Required Connector must be installed on the iFS (37° flare fitting)	IFS-BC1
---	---------

iFS House Gas Connector [Required for house (central) gas]

Required Connector must be installed on the iFS DISS Fitting	IFS-WC1
Required Connector must be installed on the iFS NIST Fitting	IFS-WC2

AirSeal® iFS Carts

Cart w/ Bottle Rack, Holds Two "E" Size CO2 Tanks	AS-ICART
Cart w/ Bottle Rack, Holds Two "E" Size CO2 Tanks, Switching Valve and Hoses included	AS-ICART-V
Cart w/ Bottle Rack, Holds Two 6" (160mm) Bottle Gas Tanks	AS-ICART-6
Cart w/ Bottle Rack, Holds Two 6" (160mm) Bottle Gas Tanks, and Switching Valve	AS-ICART-6V

iFS Valve

Switching Valve, (2) Yoke Pin Index with 18" Supply Hoses, (1) 36" Connection Hose, (1) 90° Swivel, (1) Mounting Bracket	IFS-VALVE1
--	------------

iFS Tower

(1) Yoke Pin Index mounted Switching Valve, (1) Yoke Pin Index with 18" Supply Hose and (1) 36" Connection Hose, (1) 90° Swivel	IFS-TOWER1
---	------------

iFS Low Pressure Hoses for House (Central) Gas US

36" Low Pressure Hose to connect to a DISS Wall Connection and iFS-WC1 Connector	SGQ-584CE
180" Low Pressure Hose to connect to a DISS Wall Connection and iFS-WC1 Connector	SGQ-582CE
240" Low Pressure Hose to connect to a DISS Wall Connection and iFS-WC1 Connector	SGQ-583CE
390" Low Pressure Hose to connect to a DISS Wall Connection and iFS-WC1 Connector	SGQ-585CE

iFS High Pressure Hoses for Bottle Gas

36" High Pressure Hose with a Pin Index Yoke to connect to "E" Size CO2 Tanks with a Pin Index Cylinder Valve	IFS-HPH4
1.5m High Pressure Hose to connect to "E" Size CO2 Tanks with a DIN Bottle Gas Tanks	IFS-HPH2
1.5m High Pressure Hose to connect to "E" Size CO2 Tanks with an ISO Bottle Gas Tanks	IFS-HPH3



ACCESS

SMOKE

ENERGY

INSTRUMENTS

AirSeal® Tube Sets & Access Ports



AirSeal® Filtered Tube Sets

For use with iFS AirSeal Mode Tri-Lumen Filtered Tube Set, 6/Box	ASM-EVAC1
For use with AirSeal Robotic Solution Bifurcated Filtered Tube Set, 6/Box	ASM-EVAC1-BI
For use with iFS Smoke Evacuation Mode Bifurcated Smoke Evac Filtered Tube Set, 6/Box	SEM-EVAC
For use with iFS Standard Insufflation Mode, Single Lumen Filtered Tube Set, 10/Box	SIM-TUB

AirSeal® Access Ports

8mm Cannula Cap and Obturator, Bladeless Optical Tip, Standard Length, 6/Box	IAS8-DV
8mm Cannula Cap and Obturator, Bladeless Optical Tip, Long, 6/Box	IAS8-DVL
5mm Access Port and Low Profile Obturator with Bladeless Optical Tip, 75mm Length, 6/Box	IAS5-75LP
5mm Access Port and Low Profile Obturator with Bladeless Optical Tip, 100mm Length, 6/Box	IAS5-100LP
5mm Access Port and Low Profile Obturator with Bladeless Optical Tip, 120mm Length, 6/Box	IAS5-120LP
5mm Smooth Access Port with Blunt Tip, 150mm Length (for use with single site surgical platforms), 6/Box	IASB5-150
8mm Access Port and Low Profile Obturator, with Bladeless Optical Tip, 100mm Length, 6/Box	IAS8-100LP
8mm Access Port and Low Profile Obturator, with Bladeless Optical Tip, 120mm Length, 6/Box	IAS8-120LP
12mm Access Port and Palm Grip Obturator, with Bladeless Optical Tip, 100mm Length, 6/Box	IAS12-100LPI
12mm Access Port and Obturator, with Blunt Tip, 100mm Length, 6/Box	IASB12-100
12mm Access Port and Palm Grip Obturator, with Bladeless Optical Tip, 120mm Length, 6/Box	IASB12-120LPI
12mm Access Port and Obturator, with Blunt Tip, 120mm Length, 6/Box	IASB12-120
12mm Access Port and Palm Grip Obturator, with Bladeless Optical Tip, 150mm Length, 6/Box	IASB12-150LPI

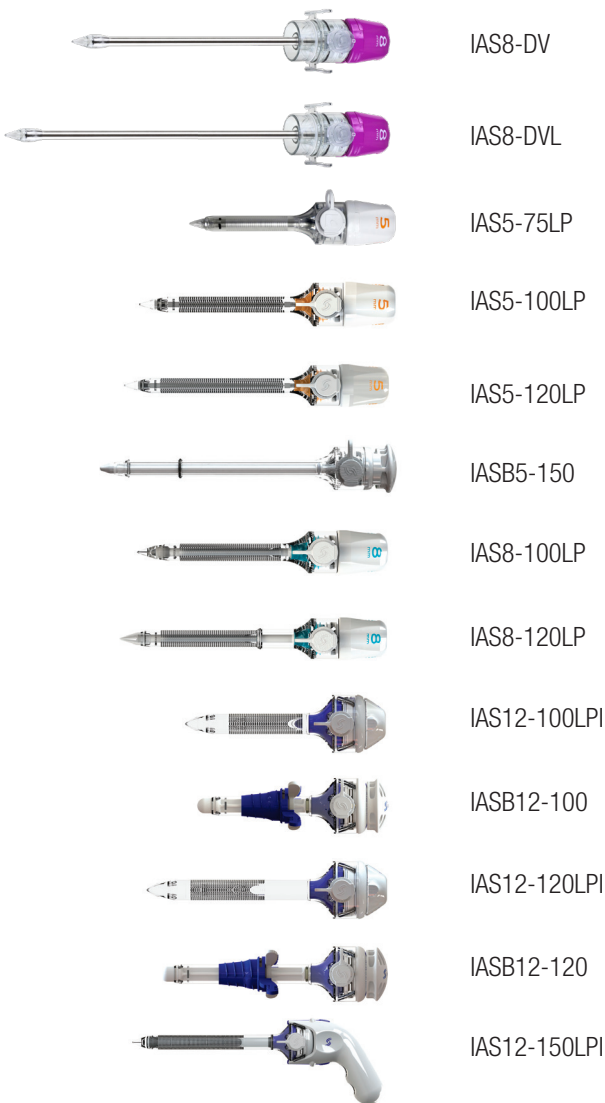

ACCESS

SMOKE

ENERGY

INSTRUMENTS

BluView™ Trocars (OUS Only)



Optical Trocars

5mm Trocar & Cannula, 70mm Length	BV-5X70
5mm Trocar & Cannula, 100mm Length	BV-5X100
5mm Obturator & Cannula, 150mm Length	BV-5X150
11mm Obturator & Cannula, 70mm Length	BV-11X70
11mm Trocar & Cannula, 100mm Length	BV-11X100
11mm Obturator & Cannula, 150mm Length	BV-11X150
12mm Obturator & Cannula, 70mm Length	BV-12X70
12mm Trocar & Cannula, 100mm Length	BV-12X100
12mm Obturator & Cannula, 150mm Length	BV-12X150

Bladeless Trocars

15mm Obturator & Cannula, 100mm Length	BV-15X100BLS
--	--------------

Bladed Trocars

5mm Trocar & Cannula, 70mm Length	BV-5X70-BLD
5mm Trocar & Cannula, 100mm Length	BV-5X100-BLD
5mm Obturator & Cannula, 150mm Length	BV-5X150-BLD
11mm Trocar & Cannula, 100mm Length	BV-11X100-BLD
11mm Obturator & Cannula, 150mm Length	BV-11X150-BLD
12mm Obturator & Cannula, 70mm Length	BV-12X70-BLD
12mm Trocar & Cannula, 100mm Length	BV-12X100-BLD
12mm Obturator & Cannula, 150mm Length	BV-12X150-BLD
15mm Obturator & Cannula, 100mm Length	BV-15X100-BLD

Blunt Tip Trocars

11mm Trocar & Cannula, 100mm Length	BV-11X100-HSS
12mm Trocar & Cannula, 100mm Length	BV-12X100-HSS

Universal Cannulas (Optical or Bladed Obturators)

5mm Cannula, 70mm Length	BV-5X70-CAN
5mm Cannula, 100mm Length	BV-5X100-CAN
11mm Cannula, 70mm Length	BV-11X70-CAN
11mm Cannula, 100mm Length	BV-11X100-CAN
11mm Cannula, 150mm Length	BV-11X150-CAN
12mm Cannula, 70mm Length	BV-12X70-CAN
12mm Cannula, 100mm Length	BV-12X100-CAN
12mm Cannula, 150mm Length	BV-12X150-CAN



ACCESS

SMOKE

ENERGY

INSTRUMENTS

Insufflation Needles & Accessories



Disposable Insufflation Needles & Tubing/Filter Set Systems

LaparoLight™ Veress Needle, 12cm (120mm), 12/cs	LLVN12012
LaparoLight™ Veress Needle, 15cm (150mm), 12/cs	LLVN15012
Insufflation Tubing (10' length) and 0.1 micron hydrophobic filter assembly with suction type connector, 10/cs	60-6050-097
Insufflation Tubing (10' length) and 0.1 micron hydrophobic filter assembly with "O" ring connector, 10/cs	60-6050-098
Insufflation Tubing (10' length) and 0.1 micron hydrophobic filter assembly with luer lock connector, 10/cs	60-6050-099

Veress Needle

Pneumoperitoneum Insufflation Needle 14 gauge, 12cm with stainless steel tip guard and band indicator, 10/case	60-6050-001
Pneumoperitoneum Insufflation Needle 14 gauge, 15cm with stainless steel tip guard and band indicator, 10/case	60-6050-002

AirSeal iFS Miscellaneous Parts & Accessories

iFS Fuse, 10 Amp	IFS-FUSE
iFS Connector O-Ring	IFS-ORING
Pin Index Yoke Seal, 10 Pack	IFS-SEAL
Connector for High Pressure Gas Hose	IFS-CON1
Upper Gas Bottle Assembly for use on -2R Carts	SQ-22213
Switching Valve for Low Pressure House Gas	IFS-HGSV
160mm Bottle Rack Base for use on -6 Carts	SQ-85601038
Pin Index Yoke JIC Male	SGQ-545
Pin Index Yoke 1/4 NPT Male	SCG-547
Valve Bracket for use on -V Carts and -2R Carts	ICART-BRACKET



LLVN12012



60-6050-001



ACCESS

SMOKE

ENERGY

INSTRUMENTS



SMOKE

-  **Surgical Smoke Evacuators**
-  **PlumePen[®] Smoke Evacuation Pencils**
-  **GoldVac[®] Smoke Evacuation Pencils**
-  **Pencil Adapters**
-  **Tubing**
-  **Tubing Adapters**
-  **Laparoscopic Solutions**
-  **Filters – For CONMED Devices**
-  **Filters – For Competitive Replacement**
-  **Accessories**



ACCESS

SMOKE

ENERGY

INSTRUMENTS

Surgical Smoke Evacuators



PX5-120



PlumeSafe® X5™

100/120 Volt Systems (includes one filter, footswitch sold separately)	PX5-120
220/240 Volt Systems (includes one filter, footswitch sold separately)	PX5-220
100/120 Volt Systems (filter, footswitch sold separately)	PX5-120NF
PlumeSafe® X5 Filter	PX5-135 Series

VC120



VisiClear®

100/120 Volt Systems (includes one filter and one footswitch)	VC120
220/240 Volt Systems (includes one filter and one footswitch)	VC220
100/120 Volt Systems (filter sold separately, includes footswitch)	VC120NF
ViroSafe® VisiClear® Filter	VS135 Series

W120



ViroVac®

100/120 Volt Systems (includes one filter and one footswitch)	W120
220/240 Volt Systems (includes one filter and one footswitch)	W220
ViroSafe® ViroVac® Filter	VS353 Series



ACCESS

SMOKE

ENERGY

INSTRUMENTS

PlumePen® Smoke Evacuation Pencils



PlumePen® Elite

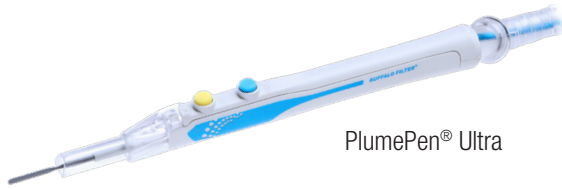

PlumePen® Ultra



PlumePen® Pro



PROTIP620

PROTIP420

PlumePen® Elite

Push Button, 1" Stainless Steel Blade	
Electrode, 10' tubing, Disposable, 20/case	PLP1020
Push Button, 1" Non-Stick Blade	
Electrode, 10' tubing, Disposable, 20/case	PLP2020
Push Button, 1" Non-Stick Blade	
Electrode, 15' tubing, Disposable, 20/case	PLP2520

PlumePen® Ultra

Push Button, 1" Non-Stick Blade	
Electrode, 10' tubing, Disposable, 20/case	PLPUL2020
Push Button, 1" Non-Stick Blade Electrode,	
15' tubing, Disposable, 20/case	PLPUL2520

PlumePen® Pro

Push Button, 1" Non-Stick Blade	
Electrode, 10' tubing, Disposable, 20/case	PLPRO4020
Push Button, 1" Non-Stick Blade	
Electrode, 15' tubing, Disposable, 20/case	PLPRO4520

Capture Ports (X-Ray Detectable)

Fits 4" (102 mm) electrodes, 20/case	PROTIP420
Fits 6" (152 mm) electrodes, 20/case	PROTIP620



ACCESS

SMOKE

ENERGY

INSTRUMENTS

GoldVac® Smoke Evacuation Pencils



GoldVac® Slim



GoldVac®



60-7524-001



60-7526-001



60-7521-001



60-7522-001



60-7523-001

GoldVac® Slim

Push Button, 1" UltraClean Blade Electrode, 10', Disposable, 20/case	60-7610-001
Push Button, 1" UltraClean Blade Electrode, 15', Disposable, 20/case	60-7670-001

GoldVac®

Push Button, 1" UltraClean Blade Electrode, 10' Tubing, Disposable, 10/case	60-7510-005
Rocker Switch, 1" UltraClean Blade Electrode, 10' Tubing, Disposable, 10/case	60-7520-005
Foot Control, 1" UltraClean Blade Electrode, 10' Tubing, Disposable, 10/case	60-7530-005
Push Button, 1" UltraClean Blade Electrode, 15' Tubing, Disposable, 10/case	60-7570-005
Rocker Switch, 1" UltraClean Blade Electrode, 15' Tubing, Disposable, 10/case	60-7580-005

GoldVac® UltraClean Electrodes

4" GoldVac UltraClean Blade, 25/case	60-7524-001
6" GoldVac UltraClean Blade, 25/case	60-7526-001
1" GoldVac UltraClean Blade with Extended Insulation, 25/case	60-7521-001
4" GoldVac UltraClean Blade with Extended Insulation, 25/case	60-7522-001
6" GoldVac UltraClean Blade with Extended Insulation, 25/case	60-7523-001



ACCESS

SMOKE

ENERGY

INSTRUMENTS

Surgical Smoke Pencil Adapters



SNAPEVAC20

SnapEvac®

10 ft (3 m) tubing with a 7/8 in (22 mm) cuff,
20/case

SNAPEVAC20



60-6828-005A

ClearVac®

GoldLine Push Button, 4' of 10mm Tubing
and 6' of 22mm Tubing, UltraClean Blade
Electrode, Holster, Single Use, Sterile, 10/case

60-6828-005A

GoldLine Rocker Switch, 4' of 10mm Tubing
and 6' of 22mm Tubing, UltraClean Blade
Electrode, Holster, Single Use, Sterile, 10/case

60-6829-005A



PA2010

PenAdapt®

3/8" (9.5 mm) x 4' (1.22 m) tubing with an
adapter to 7/8" (22 mm) x 6' (1.8 m) tube,
10/case

PA2010



ACCESS

SMOKE

ENERGY

INSTRUMENTS

Smoke Evacuation Tubing



VT38S1010



VT10424

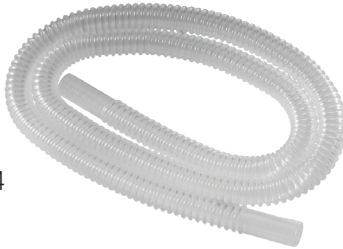

VT10206

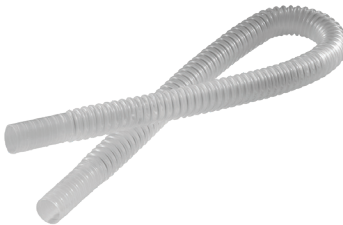

3/8" (9.5 mm) Tubing

Sterile, 10' (3.0 m) 10/case

VT38S1010

7/8" (22 mm) Tubing

Sterile

6' (1.8 m) 24/case

VT10424

10' (3.0 m) 24/case

VT10624

Non-Sterile

6' (1.8 m) with (12) 7/8" tubing-to-tubing connectors (extension tubing) 24/case

VT10324

10' (3.0 m) 24/case

VT10524

6' (1.8 m) 6/case

VT78-6

1-1/4" (32 mm) Tubing

Sterile

6' (1.8 m) 6/case

VT10206

Non-Sterile

10' (3.0 m) 6/case

VT10306

MORE OPTIONS



ACCESS

SMOKE

ENERGY

INSTRUMENTS

Smoke Evacuation Tubing

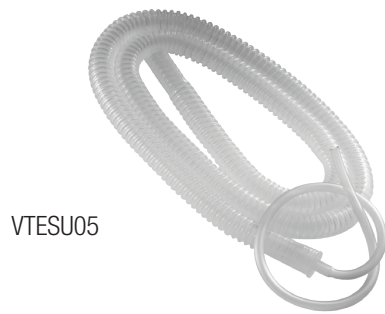

VTESU05



VTWT424



VTWT206



VTWT505

Speculum Tubing

Sterile, 7/8" (22 mm) x 6' (1.8 m) with 7/8" (22 mm) to 1/4" (6.4 mm) reducer to 1/4" (6.4 mm) x 2' (.6 m) tubing (5/case)

VTESU05

Non-Sterile, 7/8" (22 mm) x 6' (1.8 m) with 7/8" (22 mm) to 1/4" (6.4 mm) reducer to 1/4" (6.4 mm) x 2' (.6 m) tubing (5/case)

PSFTS05

7/8" (22 mm) Tubing w/ 8" (20cm) Wand & Sponge Guard

Sterile

6' (1.8 m) tubing (24/case)

VTWT424

10' (3.0 m) tubing (24/case)

VTWT624

14' (4.3 m) tubing (5/case)

VTWT805

1-1/4" (32 mm) Tubing w/ 8" (20cm) Wand & Sponge Guard

Sterile, 6' (1.8 m) tubing (24/case)

VTWT206

1-3/8" (35 mm) Tubing w/ 8" (20cm) Wand & Sponge Guard

Sterile, 6' (1.8 m) (5/case)

VTWT505

Smoke Evacuation Tubing Adapters



RF10112

Reducer Fittings/Adapters (Non-Sterile)

7/8" (22 mm) to 1/4" (6.4 mm) reducer fitting (12/case)

RF10112



ACCESS

SMOKE

ENERGY

INSTRUMENTS

Laparoscopic Solutions



PP010CS



PlumePort® Activ®

10/case

PP010CS

PlumePort®

10/case

PP010

PlumePort® SEO

12/case

PP012SEO

PlumePort® SE

12/case

BLAP100

PP010



PP012SEO



BLAP100



ACCESS

SMOKE

ENERGY

INSTRUMENTS

Filters



PX5-135-22



PlumeSafe® X5™ 3-port filter

Designed to fit PlumeSafe® X5™

7/8" (22mm), 3/8" (9.5mm), and 7/8" (22mm), 1/case PX5-135-22

7/8" (22mm), 3/8" (9.5mm), and 7/8" (22mm), 4/case PX5-1354-22

VS135



ViroSafe® VisiClear® - 3-port filter

Designed to fit VisiClear®

1/4" (6.4 mm), 3/8" (9.5 mm) and 7/8" (22 mm), 1/case VS135

1/4" (6.4 mm), 3/8" (9.5 mm) and 7/8" (22 mm), 2/case VS1352

1/4" (6.4 mm), 3/8" (9.5 mm) and 7/8" (22 mm), 4/case VS1354

VS353



ViroSafe® ViroVac® - 3-port filter

Designed to fit ViroVac®

1/4" (6.4 mm), 3/8" (9.5 mm) and 7/8" (22 mm), 1/case VS353

1/4" (6.4 mm), 3/8" (9.5 mm) and 7/8" (22 mm), 2/case VS35302

1/4" (6.4 mm), 3/8" (9.5 mm) and 7/8" (22 mm), 4/case VS35304

60-8590-001



ClearView™ - 3-port filter

Designed to fit ClearView

1/4" (6.4 mm), 3/8" (9.5 mm) and 7/8" (22 mm), 2/case 60-8590-001

MORE OPTIONS



ACCESS

SMOKE

ENERGY

INSTRUMENTS

Filters



VS06002



ViroSafe® 6 Filter - Dual male ports

Designed to fit PlumeSafe® Turbo; Porta PlumeSafe® 604

7/8" (22 mm) and 1-1/4" (32 mm), 2/case VS06002

7/8" (22 mm) and 1-1/4" (32 mm), 4/case VS06004

VSEY1-4



ViroSafe® Extra Long Life Filter - Twin male ports

Designed to fit PlumeSafe® Turbo; Porta PlumeSafe® 604

7/8" (22 mm), 2/case VSXLLT02

ViroSafe® Veterinary Filter - Dual male ports

Designed to fit PlumeSafe® Turbo; Porta PlumeSafe® 604

7/8" (22 mm) and 1-1/4" (32 mm), 1/case VSVET01

ViroSafe® 6 Odor/Hair Removal Filter - Dual male ports

Designed to fit PlumeSafe® Turbo; Porta PlumeSafe® 604

7/8" (22 mm) and 1-1/4" (32 mm), 1/case VSOH001

ViroSafe® EY Filter

Designed to fit Erbium: Yag laser applications

1-3/8" (35 mm) male port at each end—one to attach to the 1-1/4" (32 mm) opening on the Main Erbium: YAG filter and another to attach to a 1-3/8" (35 mm) tubing set, (1 Main Filter, 4 Pre-filters) VSEY1-4

BILF150



AER Defense Filter One ULPA Rated

2/case 60-8084-001

BILF200



Multi-use In-line Filter

ULPA rated media, 0.1 to 0.2 micron

Tubing attached, 10/case BILF150

Tubing detached, 10/case BILF200



ACCESS

SMOKE

ENERGY

INSTRUMENTS

Filters (For Competitive Replacement)



VSNEP04



Stryker Neptune 2 and Neptune 3 - 3-port Filter

Designed to fit Stryker Neptune 2 and Stryker Neptune 3

1/4" (6.4 mm), 3/8" (9.5 mm)
and 7/8" (22 mm), 4/case

VSNEP04

BTLDXS04



Berchtold Phoenix XS or X3 Filter

Replaces Berchtold TELEVAC XS/X3

7/8" (22 mm) port, 4/case

BTLDXS04

VSSV301



StrykeVac 3 ViroSafe® Filter - 3-port Filter

Designed to fit StrykeVac 3 Smoke Evacuation System

1/4" (6.4 mm), 3/8" (9.5 mm)
and 7/8" (22 mm), 1/case

VSSV301

1/4" (6.4 mm), 3/8" (9.5 mm)
and 7/8" (22 mm), 4/case

VSSV304

VSTR0804



Trumpf ViroSafe® Filter - 3-port Filter

Designed to fit TRUMPF EasyVac

1/4" (6.4 mm), 3/8" (9.5 mm)
and 7/8" (22 mm), 4/case

VSTR0804



ACCESS

SMOKE

ENERGY

INSTRUMENTS

Accessories



EZLINK01



EZLink®

1/case

EZLINK01

FS10004



Pneumatic Footswitch

Designed to work with CONMED surgical smoke evacuators

10' length (3.0 m), 1/case

FS10004

VSFT10



ViroSafe® Fluid Trap

Fits 7/8" (22 mm) port of filters

7/8" (22 mm) and 1/4" (6.4 mm) tubing connection ports, 10/case

VSFT10

DCCM01



Direct Connect Cables

CONMED Electrosurgical Units (certain models only) and Smoke Evacuators, 1/case

DCCM01

Covidien Electrosurgical Units (certain models only) and CONMED Smoke Evacuators, 1/case

DCCOV01

ADP ITEM



Y Adapter

7/8" (22 mm), 1/case

ADP22X22Y

MORE OPTIONS



ACCESS

SMOKE

ENERGY

INSTRUMENTS

Accessories



LA3010CL4

LaseAdapt® Hand Piece Adapter Clips

Designed for the Sciton® Contour TRL™ Erbium Scanner and ProFractional Therapy™ Laser Systems

4/case LA3010CL4



ARMSTAND

Armstand

10" (25.4 cm) x 10" (25.4 cm) x 34" (86.4 cm), 1/each ARMSTAND



ETC01

EvacuCart™

15" (38.1 cm) x 17.5" (44.5 cm) x 32" (81.3 cm), 1/each ETC01



VVWM01

ViroVac® Wall Mount Kit

Designed for ViroVac® surgical smoke evacuator

1/each VVWM01



ACCESS











SMOKE

ENERGY

INSTRUMENTS



ENERGY

-  **HelixAR™ System**
-  **ABC® Open and Laparoscopic Handpieces**
-  **ABC® Dissecting Probes**
-  **Dispersive Electrodes**
-  **System 5000™**
-  **System 2450™**
-  **Electrosurgical Pencils**
-  **Active Electrodes**
-  **Electrosurgical Forceps**
-  **Electrosurgical Cables & Adapters**



ACCESS

SMOKE

ENERGY

INSTRUMENTS

HelixAR™ System



HelixAR™ ElectroSurgical Generator with Argon Beam Coagulation (ABC®)

The HelixAR combines the advanced specialty modes of a premium ESU with the benefits of CONMED's latest ABC® Technology and is intended for use in both open and laparoscopic procedures.



60-8480-001

HelixAR™ System

HelixAR System, ABC Generator and Cart	60-8800-SET
HelixAR System, ABC Generator and Cart, with Monopolar and Bipolar Footswitch	60-8800-SYS

Footswitches

ABC Single Pedal Footswitch, 15'	60-8475-001
ABC Single Pedal Footswitch, 30'	60-8470-001
HelixAR Wireless Footswitch Kit (Monopolar & ABC Footswitch, AA Batteries, Receiver/Antenna, Operator's Manual*)	60-8480-001
Monopolar Dual Pedal Footswitch, 15'	60-6700-001
Bipolar Single Footswitch, 15'	60-5103-002

Argon Gas Tanks

D Size with 33 Cubic Feet (934.46 liters) capacity 99.998% Pure Argon Gas included	136050
Empty D Size with 33 Cubic Feet (934.46 liters) capacity	136051

Stacking Adapter

Adapter allows System 5000 ESUs to be mounted to HelixAR on a Mobile Pedestal	60-8849-001
---	-------------



60-8849-001



ACCESS

SMOKE

ENERGY

INSTRUMENTS

ABC® Open and Laparoscopic Handpieces



130344

130321

Designed for versatility and performance, CONMED's portfolio of disposable ABC® Handpieces enable surgeons to extend the benefits of ABC Technology to their patients. Each device is carefully designed for optimal clinical performance in a variety of open or laparoscopic procedures.

- Reduced blood loss
- Effective on high impedance tissue such as bone
- Reduced smoke plume for better visualization

Open Handpieces (Disposable)

Triple Option Hand Control Handpiece with 10' (3.05m) cord. Allows use of Monopolar Cut, Coagulation and ABC	130321
Single Function Hand Control Handpiece with 10' (3.05m) cord*	130344
45° Angled ABC Foot Control Handpiece with 10' (3.05m) cord*	130345

Bend-A-Beam®

3" (7.6cm) Bend-a-Beam Single Function Malleable ABC Hand Control Handpiece with 10' (3.05m) Cord. Allows Use of Monopolar ABC Coagulation. Single Use, Sterile, 10/case	134003
6" (15.2cm) Bend-a-Beam Single Function Malleable ABC Hand Control Handpiece with 10' (3.05m) Cord. Allows Use of Monopolar ABC Coagulation. Single Use, Sterile 10/case	134006
9" (22.8cm) Bend-a-Beam Single Function Malleable ABC Hand Control Handpiece with 10' (3.05m) Cord. Allows Use of Monopolar ABC Coagulation. Single Use, Sterile 10/case	134009



134003

134006

134009

MORE OPTIONS



ACCESS

SMOKE

ENERGY

INSTRUMENTS

ABC® Open and Laparoscopic Handpieces

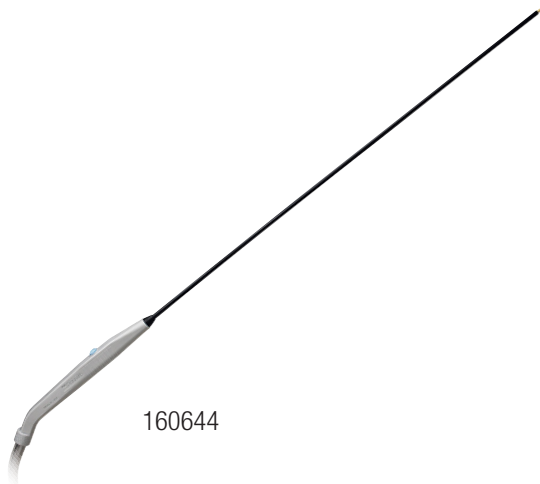

160644

Foot Control Laparoscopic Probes

Laparoscopic 10mm ABC Probe with 10' (3.05m) cord. 28cm working length*	130342
Laparoscopic 5mm ABC Probe with 10' (3.05m) cord. 28cm working length	160655

Hand Control Laparoscopic Probes

Laparoscopic 5mm ABC Probe with 10' (3.05m) cord. 28cm working length	160656
Laparoscopic 5mm ABC Probe with 10' (3.05m) cord. 36cm working length	160636
Laparoscopic 5mm ABC Probe with 10' (3.05m) cord. 44cm working length	160644

ABC® Dissecting Probes



ABC® technology in contact mode allows surgeons to efficiently dissect while employing the benefits of Argon. Surgeons can also continue to use ABC® in non-contact mode simply by pulling the ABC® Dissecting Electrodes away from tissue.

Simple to use, ABC® Dissecting Electrodes attach to any of the below CONMED ABC® handpieces to convert from Argon Beam Coagulation to Argon Dissect.

- 130342 Lap Foot Control 10mm ABC Probe
- 130344 Single Function Hand Control ABC Handpiece
- 130345 Angled (45°) ABC® Foot Control Handpiece

ABC Dissecting Electrodes

ABC Dissecting Blade Electrode converts Argon Beam Coagulation to Argon Beam Dissect, 20/Case	139330
ABC Dissecting Blunt Needle Electrode converts Argon Beam Coagulation to Argon Beam Dissect, 20/Case	139331



139330



139331



ACCESS

SMOKE

ENERGY

INSTRUMENTS

Dispersive Electrodes



ThermoGard®

ThermoGard® Dispersive Electrodes

Adult Single Dispersive Electrode (for Patients >15 kg), Single Use, Pre-attached 10' (3.05m) Cable, 80/case 1/pkg	51-7810
Adult Dual Dispersive Electrode (for Patients >15 kg), Single Use, Pre-attached 10' (3.05m) Cable, 80/case 1/pkg	51-7310
Adult Dual Dispersive Electrode (for Patients >15 kg), Single use, without Cable (use cable T-229), 80/case 1/pkg	51-7410
Pediatric Dual Dispersive Electrode (for Patients 5-15 kg), Single use, Pre-attached 10' (3.05m) Cable, 80/case 1/pkg	51-7710

ThermoGard® Plus ABC Dispersive Electrodes

Adult Dual Dispersive Electrode (for patients >15 kg), Single use, Pre-attached 10' (3.05m) Cable, 40/case 1/pkg	7-382
Pediatric Dual Dispersive Electrode (for patients 5-15 kg), Single use, Pre-attached 10' (3.05m) Cable, 40/case 1/pkg	7-383
Adult Single Dispersive Electrode (for patients >15 kg), Single use, Pre-attached 10' (3.05m) Cable, 40/case 1/pkg	7-384

MORE OPTIONS



ACCESS

SMOKE

ENERGY

INSTRUMENTS

Dispersive Electrodes

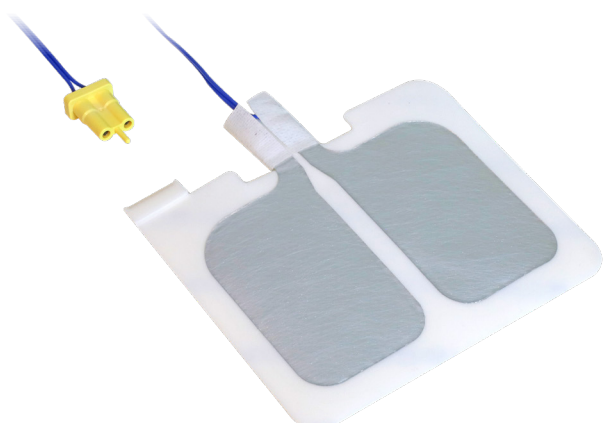

SureFit™



MacroLyte®

SureFit™ Dual Dispersive Electrodes

SureFit Dual Dispersive Electrode (for patients > 4.8 lbs.), Single use, Pre-attached 10' (3.05m) Cable, 100/case, 25/box	410-2000
SureFit Dual Dispersive Electrode (for patients > 4.8 lbs.), Single use, Pre-attached 15' (4.575m) Cable, 100/case, 25/box	410-2100
SureFit Dual Dispersive Electrode (for patients > 4.8 lbs.), Single use, without Cable, resealable, 5-pack pouch (use reusable cable # T229), 100/case, 5/pkg	410-2200

MacroLyte® Dispersive Electrodes

Adult Single Dispersive Electrode (for patients >15 kg), Single use, Pre-attached 10' (3.05m) Cable, 100/case, 25/box	400-2100
Adult Single Dispersive (for patients >15 kg) No Cable, 100/case 50/box 1/pkg	400-2349
Adult Single Dispersive Electrode (for patients >15 kg), Single use, without cable, resealable 5-pack pouch (use reusable cable # T229), 100/case, 20/box, 5/pkg	400-2700
Pediatric Single Dispersive Electrode (for patients 5-15 kg), Single use, Pre-attached 10' (3.05m) Cable, 100/case, 25/box	425-2200
Pediatric Dual Dispersive Electrode (for patients 5-15 kg), Single use, Pre-attached 10' (3.05m) Cable, 100/case, 25/box	425-2508
Premie Single Dispersive Electrode (for patients < 5 kg), Single use, Pre-attached 10' (3.05m) Cable, 40/case, 10/box	440-2400
Infant Single Dispersive Electrode (for patients 5-15 kg), Single use, Pre-attached 10' (3.05m) Cable, 60/case, 15/box	450-2300

MORE OPTIONS 



ACCESS

SMOKE

ENERGY

INSTRUMENTS

Dispersive Electrodes

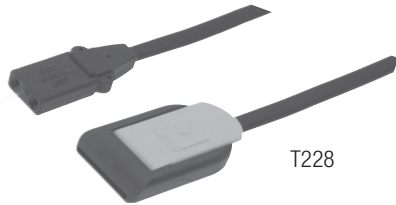

T228



A238

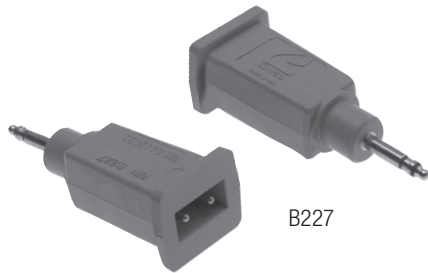

B227



B260

Cables for Dispersive Electrodes

Cable for use with all ARM-equipped and Valleylab REM-equipped generators.

10' (3.05m), 1/ea

T229

Cable for use with all ARM-equipped and Valleylab REM-equipped generators.

15' (4.57m), 1/ea

T229-5M

Cable for use with single dispersive electrodes and non-contact quality monitoring generators; 10' (3.05m), 1/ea

T228

Dispersive Electrode Adapters and Cables

Dispersive Electrode Adapter. For use with Valleylab generators without REM (single-foil only); Wallach Leep 100, 1/ea

B204

Dispersive Electrode Adapter. For use with all Aspen Labs; Birtcher 3000, 4400; Davol/Bard/Birtcher 5000 without PSS; Bicap 60, 200, 1/ea

B205

Dispersive Electrode Adapter. For use with Erbe and Elmed generators, 1/ea

B210

Dispersive Electrode Adapter. Allows CONMED ABC generators to use Valleylab dual-foil dispersive electrodes, 1/ea

A238

Dispersive Electrode Adapter. For use with Ritter Bovie Specialist, 1/ea

B227

Dispersive Electrode Adapter. For use with Olympus S-P cables retrofit with CONMED Adapter and CONMED Single Foil Dispersive electrodes, 1/ea

B260



ACCESS

SMOKE

ENERGY

INSTRUMENTS

System 5000™



System 5000 ESU

System 5000 ESU, 120V	60-8005-001
System 5000 ESU, 100V - 240V (Symbols Front Panel)	60-8005-002
System 5000 ESU, 100V - 240V	60-8005-003
System 5000 – 120V ESU, Mobile Pedestal, Upper Storage Basket, Lower Storage Basket, Monopolar Footswitch, Bipolar Footswitch (English Front Panel)	60-8005-SYS
System 5000 – 100V to 240V ESU, Mobile Pedestal, Upper Storage Basket, Lower Storage Basket, Monopolar Footswitch, Bipolar Footswitch (Symbols Front Panel)	60-8015-SYS
System 5000 – 100V to 240V ESU, Mobile Pedestal, Upper Storage Basket, Lower Storage Basket, Monopolar Footswitch, Bipolar Footswitch (English Front Panel)	60-8018-SYS

Mobile Pedestal

Mobile Pedestal including Upper and Lower Storage Baskets	60-8040-001
--	-------------

Footswitches

Monopolar Footswitch with 15 ft. cable	60-6700-001
Bipolar Footswitch with 10 ft. cable	60-5103-001
Bipolar Footswitch with 15 ft. cable	60-5103-002

Basket

Saddlebag Lower Basket	60-8041-001
------------------------	-------------

Stacking Adapter

Adapter allows two System 5000 ESUs to be mounted on a Mobile Pedestal	60-8030-001
---	-------------

Manuals / CD

Operator's Manual, System 5000 ESU	60-8016-ENG
In-Service CD, System 5000 ESU	60-8026-001
In-Service DVD, System 5000 ESU	60-8026-DVD
Service Manual, System 5000 ESU	60-8017-ENG



ACCESS

SMOKE

ENERGY

INSTRUMENTS

System 2450™



System 2450 ESU

System 2450 ESU, 100V	60-2450-100
System 2450 ESU, 120V	60-2450-120
System 2450 ESU, 220V	60-2450-220
System 2450 ESU, 230-240V	60-2450-230
System 2450 Cart	60-7152-001

Footswitches

Monopolar Footswitch with 15 ft. cable	60-6700-001
Bipolar Footswitch	60-5103-001

Stacking Adapter

Stacking Adapter for System 2450	60-6963-001
----------------------------------	-------------

Manuals / CD

Operator's Manual, System 2450 ESU	60-2451-ENG
In-Service CD, System 2450 ESU	60-2453-001
Service Manual, System 2450 ESU	60-2454-ENG

Universal ESU Cart

Assembled Cart	60-5480-001
----------------	-------------



ACCESS

SMOKE

ENERGY

INSTRUMENTS

Electrosurgical Pencils



GoldLine® Electrocautery Pencils

Push Button, Hand Switch Pencils

UltraClean® Blade, Holster, 10' Cable, 40/case	131309A
UltraClean® Blade, Holster, 15' Cable, 40/case	131326A
Standard Blade, Holster, 10' Cable, 40/case	130309A
Standard Blade, Holster, 15' Cable, 40/case	130326A
Standard Blade, Holster, Tip Cleaner, 10' Cable, 40/case	130303A
Needle Electrode, Holster, 10' Cable, 40/case	130302A
Extended Insulated Blade, Holster, 10' Cable, 40/case	138114A

Rocker Switch, Hand Switch Pencils

UltraClean® Blade, Holster, 10' Cable, 40/case	131307A
UltraClean® Blade, Holster, 15' Cable, 40/case	131327A
Standard Blade, Holster, 10' Cable, 40/case	130307A
Standard Blade, Holster, 15' Cable, 40/case	130327A
Standard Blade, Holster, Tip Cleaner, 10' Cable, 40/case	130304A
Needle Electrode, Holster, 10' Cable, 40/case	130301A
Ext. Blade 10' (3.05m) Cable, Holster 40/case 1/pkg	138115A

Foot Control Pencils

UltraClean® Blade, Holster, 10' Cable, 40/case	138650A
Needle Electrode, Holster, 15' Cable, 40/case	138652A
Blade Electrode, Holster, 10' Cable, 40/case	138659A

Tip Cleaner

Tip Cleaner, Single Use, Sterile, 100/case	TC200
--	-------

MORE OPTIONS



ACCESS

SMOKE

ENERGY

INSTRUMENTS

Electrosurgical Pencils



Pencil Accessories

Disposable Safety Holster 40/case 1/pkg	137668
--	--------

ValueBlue™ Electrosurgical Pencils

Push-Button Pencil, 1" Stainless Steel Blade, Sterile, 10/case 1/pkg	130402
Push-Button Pencil, 1" ValueBlue Coated Electrode, Sterile, 10/case 1/pkg	130403
Rocker-Switch Pencil, 1" Stainless Steel, Sterile, 10/case 1/pkg	130404
Rocker-Switch Pencil, 1" ValueBlue Coated Electrode, Sterile, 10/case 1/pkg	130405

Suction Coagulators

Foot Control, 10 French, 6" (15m), Monopolar, Single Use; Sterile 10' (3.0m) Cordset, 25/case	130187
Hand Control, 10 French, 6" (15cm), Monopolar, Single Use; Sterile 10' (3.0m) Cordset, 25/case	130188



ACCESS

SMOKE

ENERGY

INSTRUMENTS

Active Electrodes

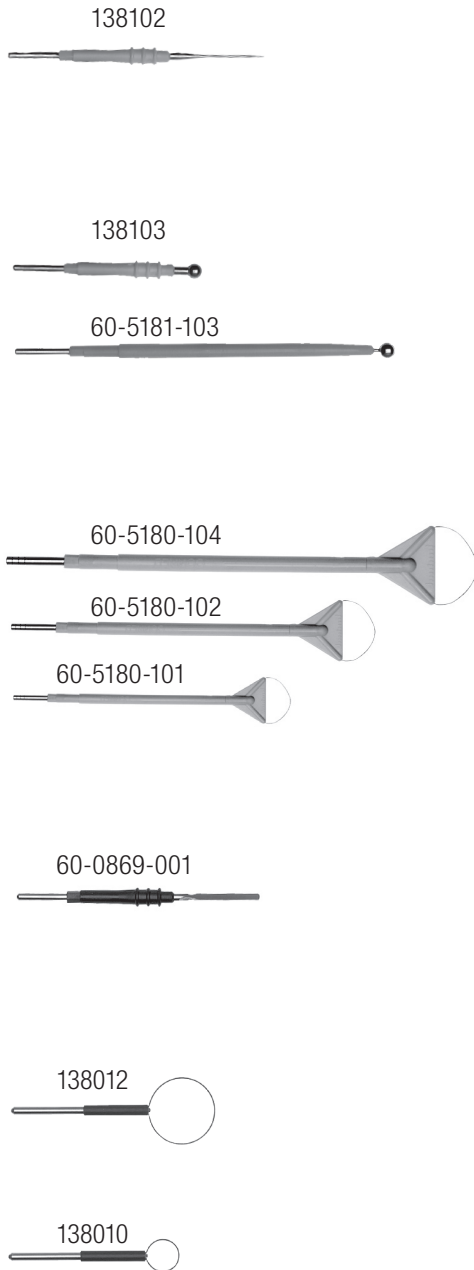

Disposable Stainless Steel Needles

Needle Electrode w/ Hex Hub, 40/case 1/pkg	138102
Needle Electrode w/ Extended Insulation; Hex Hub, 40/case 1/pkg	138105
6" Needle Electrode w/ Hex Hub 40/case 1/pkg	138108

Disposable Stainless Steel Balls

3/16" diameter, with Hex Hub, 40/case 1/pkg	138103
3mm diameter, 10cm shaft, 5/case 1/pkg	60-5181-102
5mm diameter, 10cm shaft, 5/case 1/pkg	60-5181-103

Disposable Loop Excision Electrodes

"T" Style, 12x8mm, 5/case 1/pkg	60-5180-101
"T" Style, 15x10mm, 5/case 1/pkg	60-5180-102
"T" Style, 20x10mm, 5/case 1/pkg	60-5180-104

Reusable Blades

Straight Blade Electrode, 1" (2.54cm) length; Hex Hub, 6/case 1/pkg	60-0869-001
---	-------------

Reusable Loops and Conization

Round Loop Electrode, 3/8" (0.95cm) diameter, 2" (5.08cm) length, 5/case 1/pkg	138010
Round Loop Electrode, 1/4" (0.64cm) diameter, 1 ^{3/4} " (4.45cm) length, 5/case 1/pkg	138011
Round Loop Electrode, 3/4" (1.91cm) diameter, 2.1" (5.53cm) length, 5/case 1/pkg	138012

MicroNeedles

3cm, 0° MicroNeedle, 10/case	138505-10
4cm, 0° MicroNeedle, 10/case	138506-10

MORE OPTIONS 



ACCESS

SMOKE

ENERGY

INSTRUMENTS

Active Electrodes

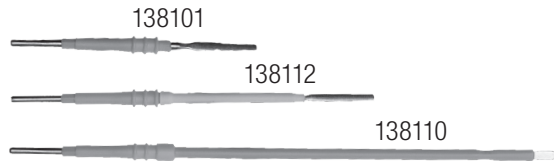
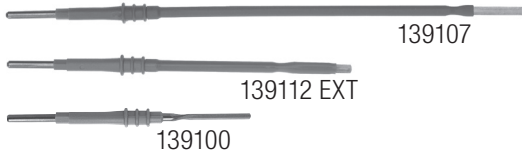

Reusable Extender

Straight Electrode Extender, 5" (12.7cm) 5/case 1/pkg	138026
--	--------

Disposable UltraClean® Blades

1" UltraClean® Blade, 50/case 1/pkg	139100
1" UltraClean® Blade with Extended Insulation, 50/case 1/pkg	139104EXT
4" UltraClean® Blade, 50/case 1/pkg	139112
4" UltraClean® Blade with Extended Insulation, 50/case 1/pkg	139112EXT
6" UltraClean® Blade, 50/case 1/pkg	139107
6" UltraClean® Blade with Extended Insulation, 50/case 1/pkg	139110EXT

Disposable Stainless Steel Blades

Heavy Flat Blade Electrode w/ Hex Hub, 40/case 1/pkg	138100
Standard Flat Blade Electrode w/ Hex Hub, 40/case 1/pkg	138101
Flat Blade Electrode with Extended Insulation; Hex Hub, 40/case 1/pkg	138104
6" Flat Blade Electrode with Hex Hub 40/case 1/pkg	138107
6" Flat Blade Electrode with Extended Insulation; Hex Hub, 40/case 1/pkg	138110
4" Flat Blade Electrode with Hex Hub 40/case 1/pkg	138112
3 ^{1/2} " Flat Blade Electrode with Hex Hub 40/case 1/pkg	138113

MORE OPTIONS 



ACCESS

SMOKE

ENERGY

INSTRUMENTS

Active Electrodes



139102

Disposable UltraClean® Needles

1" UltraClean® Needle, 50/case 1/pkg	139102
1" UltraClean® Needle with Extended Insulation, 50/case 1/pkg	139105EXT
6" UltraClean® Needle, 50/case 1/pkg	139108
6" UltraClean® Needle with Extended Insulation, 50/case 1/pkg	139025EXT

Disposable Laparoscopic Electrodes

Spatula

5mm x 32cm working length, 1/pkg, 5/cs	60-5159-001
5mm x 27cm working length, 1/pkg, 5/cs	60-5159-002
5mm x 32cm working length w/ 4mm pin, 1/pkg, 5/cs	60-5159-004

"L" Hook

5mm x 32cm working length, 1/pkg, 5/cs	60-5163-001
5mm x 27cm working length, 1/pkg, 5/cs	60-5163-002
5mm x 32cm working length w/ 4mm pin, 1/pkg, 5/cs	60-5163-004

Straight Blade

5mm x 32cm working length, 1/pkg, 5/cs	60-5160-001
5mm x 27cm working length, 1/pkg, 5/cs	60-5160-002

"J" Hook

5mm x 32cm working length, 1/pkg, 5/cs	60-5164-001
5mm x 27cm working length, 1/pkg, 5/cs	60-5164-002
5mm x 32cm working length w/ 4mm pin, 1/pkg, 5/cs	60-5164-004

Hook Blade

5mm x 32cm working length, 1/pkg, 5/cs	60-5162-001
--	-------------



Spatula



"L" Hook



Straight Blade



"J" Hook



Hook Blade



ACCESS

SMOKE

ENERGY

INSTRUMENTS

Electrosurgical Forceps (Reusable, Non-Sterile)

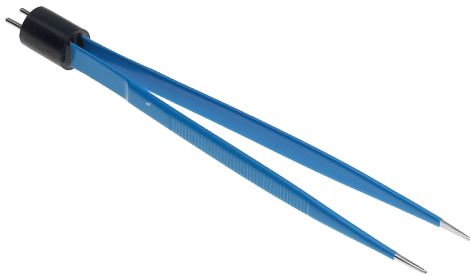
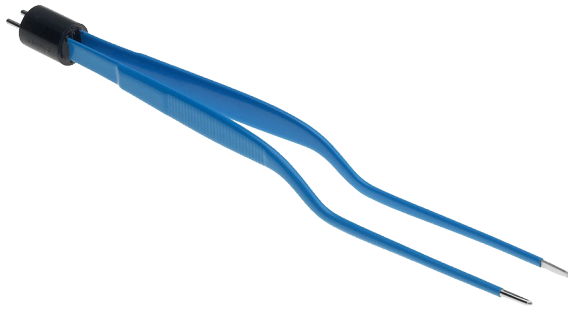

Foot Control Bipolar Forceps – Bayonet

Scoville-Greenwood Bayonet, 7¾” (19.7cm) Length, 1.5mm Tip, Insulated	60-1765-001
Cushing Bayonet, Micro Tip, 7½” (19.1cm) Length, 0.7mm Tip, Insulated	60-1769-001
Hardy Bayonet, Micro Tip with Stops, 8¼” (21.0cm) Length, 0.5mm Tip, Non-Insulated	60-1770-001
Bayonet, Straight 20cm Length, 2.0mm Tip, Insulated	60-7400-001
Bayonet, Straight, 20cm Length, 1.0mm Tip, Insulated	60-7401-001

Foot Control Bipolar Forceps – Jewelers

Jewelers Micro Tip, Curved, 4” (10.2cm) Length, 0.4mm Tip, Insulated	60-1766-001
Jewelers Micro Tip, Straight, 4” (10.2cm) Length, 0.4mm Tip, Insulated	60-1767-001
Jewelers Micro Tip, Curved, 4” (10.2cm), 0.4mm Tip, Non-Insulated	136011
Jewelers, Straight, 11cm Length, 0.5mm Tip, Insulated	60-7403-001

Foot Control Bipolar Forceps – Semkin

Micro Tip with Stops, 5½” (14.0cm) Length, 0.7mm Tip, Non-Insulated	60-1771-001
Straight, 6” (15.2cm) Length, 1.5mm Tip, Insulated	60-1772-001

MORE OPTIONS



ACCESS

SMOKE

ENERGY

INSTRUMENTS

Electrosurgical Forceps (Reusable, Non-Sterile)



Foot Control Bipolar Forceps – Adson

Straight, 5" (12.7cm) Length, 1.0mm Tip, Insulated	60-1768-001
Straight, 13cm Length, 1.0mm Tip, Insulated	60-7404-001

Foot Control Bipolar Forceps – Iris

Straight, 3½" (8.9cm) Length, 0.4mm Tip, Insulated	60-1773-001
Curved, 3½" (8.9cm) Length, 0.5mm Tip, Insulated	60-1774-001

Foot Control Bipolar Forceps – Straight

Cushing, Straight, 7" (17.8cm) Length, 1.5mm Tip, Not Insulated	136016
--	--------

Hand Control Bipolar Forceps

Scoville-Greenwood Bayonet, 7¾" (19.7cm) Length, 1.5mm Tip, Insulated	60-5121-001
Jewelers, Straight Tip 4" (10.2cm) Length, 0.4mm Tip, Insulated	60-5122-001
Semkin, Micro Tip, 5½" (14.0cm) Length, 0.7mm Tip, Insulated	60-5123-001

Foot Control Monopolar Forceps

Potts-Smith, Straight Tip with Cable, 7" (17.8cm) Length, 2.0mm Tip, Insulated	60-0821-001
---	-------------

Hand Control Monopolar Forceps

Bayonet, Straight Tip with Cable, 7½" (19.1cm), 2.0mm Tip, Insulated	60-0812-001
---	-------------



ACCESS

SMOKE

ENERGY

INSTRUMENTS

Electrosurgical Cables & Adapters



60-0823-001

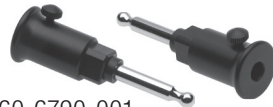

60-6790-001

Active Instrument Adapter – Monopolar

Universal Button Adapter for foot control monopolar accessories; fits Bovie #12 type output sockets, 1/ea

60-0823-001

Universal Twist-Lock Adapter for foot control monopolar accessories; fits Bovie #12 type output sockets, 1/ea

60-6790-001

Active Instrument Adapter – Bipolar

Coaxial Bipolar Adapter, for use with CONMED Excalibur Plus PC®, Sabre® 2400, Sabre® 180, System 7500® and 7550™, 1/ea

133001

Coaxial Bipolar Adapter, for use with CONMED System 2450™, System 5000™, and Valleylab electrosurgical units, 1/ea

133002

Disposable Cords

Monopolar

Disposable Monopolar Cord (Gray), .09375" (2.4mm) receptacle, 10' (3.05m) length, Single-use, Sterile, 1/pkg, 50/cs

60-5168-001

Disposable Monopolar Cord (Blue), .15625" (4mm) receptacle, 10' (3.05m) length, Single-use, Sterile, 1/pkg, 50/cs

60-5168-005

Disposable Monopolar TUR/Endoscopic Cable for ACMI, 10' (3.05m)

60-2121-001

Bipolar

Disposable Bipolar Cord, 12' (3.66m) length, Single-use, Sterile, 1/pkg, 40/cs

135166

Disposable Footswitching Bipolar Cable, 10' (3.05m)

60-6102-002



133001



133002



60-5168-001



60-5168-005



60-2121-001



315166



60-6102-002

MORE OPTIONS



ACCESS

SMOKE

ENERGY

INSTRUMENTS

Electrosurgical Cables & Adapters



60-5169-001

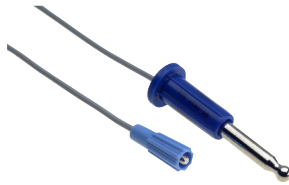

60-0824-001

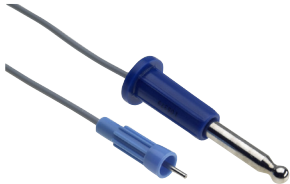

60-0816-001

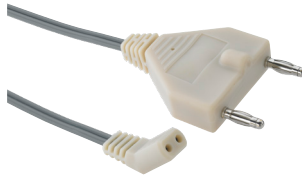

60-8046-001



60-5130-001



60-5132-001

Reusable Cables

Monopolar

Reusable Monopolar, 4mm (.15625") pin receptacle, 10' (3.05m) length, Non-sterile, 1/ea 60-5169-001

Reusable, Footswitching, Monopolar Forceps Cable with threaded male connector, 10' (3.05m) 60-0824-001

Reusable Monopolar TUR Cable with Standard (Bovie #12) Plug 60-0816-001

Bipolar

Reusable, Footswitching, Bipolar Forceps Cable, 12' (3.66m) 60-8046-001

Reusable, Handswitching, Bipolar Cable, use with Bistat™ and System 7550, 12' (3.66m) 60-5130-001

Reusable, Handswitching, Bipolar Cable, use with System 2450 and System 5000, 12' (3.66m) 60-5132-001

Reusable Footswitching Bipolar Forceps Cable, 10' (3.05m) use with Wolf Kleppinger forceps Twin banana plug machine connectors QI-2301



ACCESS

SMOKE

ENERGY

INSTRUMENTS



INSTRUMENTS

-  **LaparoVue®** Visibility System
-  **DetachaTip®** Laparoscopic Instruments
-  **Disposable Scissors**
-  **VCare® Plus** Uterine Manipulators
-  **Core™** Suction / Irrigation
-  **Universal Plus®** Suction / Irrigation
-  **Irrigation Pumps**
-  **Anchor*** Specimen Bags
-  **CONMED** Specimen Bags
-  **Specialty Products**



ACCESS

SMOKE

ENERGY

INSTRUMENTS

LaproVue® Visibility System



LAPVUE10

LaproVue®

LaproVue Visibility System, 10/box	LAPVUE10
VueTip™ Trocar Swab Accessory Kit, 10/box	VUETIP10



VUETIP10



ACCESS

SMOKE

ENERGY

INSTRUMENTS

DetachaTip® Laparoscopic Instruments



Fenestrated
(Duckbill)
2-1008, 2-4307



Allis
2-1019, 2-4319



Endoweave™
2-1028, 2-4328



Babcock
2-1005, 2-4305, 2-1014



Curved (Maryland)
2-1009, 2-4308



Tapered (Dolphin)
2-1018



Multi-Use Handle
1-1010

DetachaTip II Multi-Use Scissors – Sterile

Curved Metzenbaum, 5mm x 33cm length, 1/box	2-1003
Curved Metzenbaum, 5mm x 43cm length, 1/box	2-4301
Curved Mini-Metzenbaum, 5mm x 33cm length, 1/box	2-1004

DetachaTip II Multi-Use Graspers - Sterile

Fenestrated (Duckbill), 5mm x 33cm length, 1/box	2-1008
Fenestrated (Duckbill), 5mm x 43cm length, 1/box	2-4307
Allis, 5mm x 33cm length, 1/box	2-1019
Allis, 5mm x 43cm length, 1/box	2-4319
Endoweave™, 5mm x 33cm length, 1/box	2-1028
Endoweave™, 5mm x 43cm length, 1/box	2-4328
Babcock, 5mm x 33cm length, 1/box	2-1005
Babcock, 5mm x 43cm length, 1/box	2-4305
Babcock, 10mm x 33cm length, 1/box	2-1014

DetachaTip II Multi-Use Dissectors - Sterile

Curved (Maryland), 5mm x 33cm length, 1/box	2-1009
Curved (Maryland), 5mm x 43cm length, 1/box	2-4308
Tapered, 5mm x 33cm length, 1/box	2-1018

DetachaTip II Multi-Use Handles

Standard Handle with ratchet, Non-Sterile, 1/box	1-1010
--	--------



ACCESS

SMOKE

ENERGY

INSTRUMENTS

Disposable Scissors



1411



1412

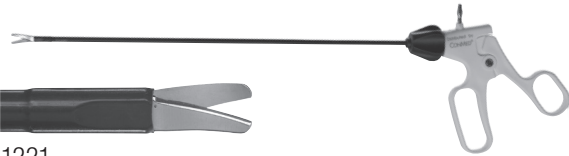

1221



1222

Laparoscopic Disposable Scissors

Reflex® Short Curved, 5mm x 32cm length,
(cord not included), 1/pkg, 6/cs

1411

Reflex® Long Curved, 5mm x 32cm length,
(cord not included), 1/pkg, 6/cs

1412

Short Curved Mini Metz, 5mm x 33cm
length, (cord not included), 1/pkg, 10/cs

1221

Long Curved Metz Scissors, 5mm x 33cm
length, (cord not included), 1/pkg, 10/cs

1222



ACCESS

SMOKE

ENERGY

INSTRUMENTS

VCare® Uterine Manipulators



VCare Plus



VCare DX Plus

VCare Plus

Small (32mm), Cervical Cup, 8/cs	60-6085-200A
Medium (34mm), Cervical Cup, 8/cs	60-6085-201A
Large (37mm), Cervical Cup, 8/cs	60-6085-202A
X-Large (40mm), Cervical Cup, 8/cs	60-6085-203A

VCare DX Plus

VCare DX Plus Manipulator, 8/cs	60-6080-000A
---------------------------------	--------------



ACCESS

SMOKE

ENERGY

INSTRUMENTS

Core™ Suction / Irrigation



CD856



CD860



CD849

Suction Probes (Reusable)

10mm x 32cm with Holes	CD856
5mm x 32cm with Holes	CD860
5mm x 45cm with Holes	CD849

Handpieces (Disposable)

Single bag, 10/box	CD8300
Single bag, 5mm, 32cm probe, 10/box	CD8185
Dual or Single bag, 10/box	CD8302
Dual or Single bag, 5mm, 32cm probe, 10/box	CD8190
Handpiece only, 20/box	CD8450

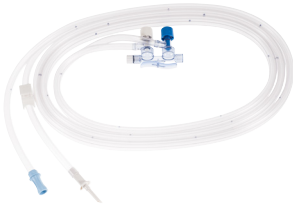

CD8300



CD8185

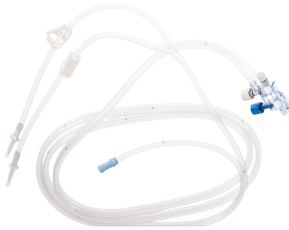

CD8302

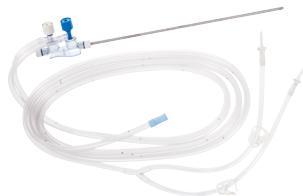

CD8190



CD8450



ACCESS

SMOKE

ENERGY

INSTRUMENTS

Universal Plus® Suction / Irrigation



Pistol Grip

Pistol Grip

Foot Control E/S, Hand Control S/I, w/10' HiFlo tubing, "Y" connector with spikes for dual or single bag, Universal cord, 10/cs	60-6010-000
Hand Control E/S (Buttons), w/10' HiFlo tubing, "Y" connector with spikes for dual or single bag, Monopolar cord, 10/cs	60-6010-002
Hand Control S/I, w/10' HiFlo Tubing, "Y" Connector with spikes for dual or single bag, 10/cs	60-6020-100



Straight Handle

Straight handle

Hand Control S/I, w/10' HiFlo tubing, "Y" Connector with spikes for dual or single bag, Universal cord, 10/cs	60-6010-001
Hand Control E/S (Buttons) and S/I, w/10' HiFlo tubing, "Y" Connector with spikes for dual or single bag, Monopolar cord, 10/cs	60-6010-003
Hand Control E/S (Rocker switch) and S/I, w/10' HiFlo tubing, "Y" Connector with spikes for dual or single bag, Monopolar cord, 10/cs	60-6010-005
Hand Control S/I, w/10' HiFlo Tubing, "Y" Connector with spikes for dual or single bag, 10/cs	60-6020-115

5mm Electrosurgery Electrodes w/ Suction/Irrigation Stealth Eschar Resistant Coating

L-Hook with non-stick coating	
27cm	60-5274-127
32cm	60-5274-132
44cm	60-5274-144
Spatula with non-stick coating	
27cm	60-5274-027
32cm	60-5274-032
44cm	60-5274-044
Needle with non-stick coating	
32cm	60-5274-932



ACCESS

SMOKE

ENERGY

INSTRUMENTS

Universal Plus® Suction / Irrigation



60-6002-302



60-6002-309



60-6001-203



60-6001-205

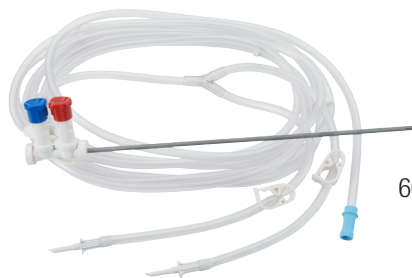

60-6005-505

5mm Electrosurgery Electrodes w/ Suction/Irrigation

L-Hook	
27cm	60-5272-127
32cm	60-5272-132
Spatula	
32cm	60-5272-032

Interchangeable Reusable Stainless Steel Suction/Irrigation Cannulas

5mm sump cannula with side holes, 32cm, 1/ea	60-6002-302
5mm sump cannula with side holes, 44cm, 1/ea	60-6002-309

Interchangeable Disposable Stainless Steel Suction/Irrigation Cannulas – Single Use

10mm Sump Cannula with side holes, 32cm	60-6001-110
5mm Sump Cannula w/ side holes, 32cm	60-6001-203
5mm Sump Cannula w/ side holes, 44cm	60-6001-205

FloVac®

FloVac with Universal Connector, Dual or Single bag, 10/cs	60-6005-500
FloVac with 5mm x 32cm Cannula, Dual or Single bag, 10/cs	60-6005-505



ACCESS

SMOKE

ENERGY

INSTRUMENTS

Irrigation Pumps



270178



270123



270165



270179



CD984A

Pressure Infuser Irrigation Pumps

1-Liter Pressure Infuser Irrigation Pump Takes standard irrigation bag, 500 – 1000ml	270178
Dual 1-Liter Pressure Infuser Irrigation Pump, Takes two bags, 500 – 1000ml, great for irrigators with dual spikes	270123
3-Liter Pressure Infuser Irrigation Pump Most versatile, takes single bag, 500 – 3000ml, Also can take 2 bags, 500 – 1000ml	270165
Power Pack, Infuser Pump Compressor AC powered air compressor for 270178, 270123, and 270165 Infuser Irrigation Pumps	270179

Gas Source Quick Connect Couplers

Ohmeda, Air	CD984A
-------------	--------



ACCESS

SMOKE

ENERGY

INSTRUMENTS

Anchor* Laparoscopic Specimen Bags



TRS175SB2

TRS-ROBO-8



TRS-ROBO-8L



TRS100SB2



TRS100SB2L



TRS-ROBO-12



TRS-VATS-15



TRS190SB2



TRS-TV-25



TRS070



Anchor* Tissue Retrieval System

8mm, 2.0" (5.1cm) diameter, 5.5" (14.0cm) bag length, 125ml vol., 5/cs	TRS-ROBO-8
8mm, 2.2" (5.6cm) diameter, 5.5" (14.0cm) bag length, 175ml vol., 5/cs	TRS-ROBO-8L
10mm, 2.2" (5.6cm) diameter, 5.5" (14.0cm) bag length, 175ml vol., 5/cs	TRS100SB2
10mm, 3.0" (7.6cm) diameter, 5.5" (14.0cm) bag length, 250ml vol., 5/cs	TRS100SB2L
12mm, 3.0" (7.6cm) diameter, 5.5" (14.0cm) bag length, 250ml vol., 5/cs	TRS-ROBO-12
15mm, 5.5" (14.0cm) diameter, 9.9" (25.4cm) bag length, 1200ml vol., 3/cs	TRS-VATS-15
15mm, 5.5" (14.0cm) diameter, 9.9" (25.4cm) bag length, 1200ml vol., 3/cs	TRS175SB2
15mm, 6.0" (5.1cm) diameter, 10.4" (26.5cm) bag length, 1800ml vol., 3/cs	TRS190SB2
25mm, 6.5" (16.5cm) diameter, 15.0" (38.1cm) bag length, 6000ml vol., 3/cs	TRS-TV-25

Bag Alone

10mm, 2.2" (5.6cm) diameter, 5.5" (14.0cm) bag length, 175ml vol., 10/cs	TRS070
10mm, 3.5" (8.9cm) diameter, 5.5" (14.0cm) bag length, 250ml vol., 10/cs	TRS080
15mm, 5.5" (14.0cm) diameter, 9.9" (25.4cm) bag length, 1200ml vol., 5/cs	TRS090



ACCESS

SMOKE

ENERGY

INSTRUMENTS

Disposable Laparoscopic Specimen Bags



SB936



SB534



SB1036



SB1079

Attached Memory Wire Bag

Polymer

5mm, 3" (7.6cm) diameter,
4" (10.2cm) length, 120ml vol., 10/cs SB534

10mm, 3" (7.6cm) diameter,
6" (15.24cm) length, 330ml vol., 5/cs SB936

10mm, 5" (12.7cm) diameter,
7" (17.7cm) length, 750ml vol., 5/cs SB957

12mm, 7.5" (19.1cm) diameter,
9" (22.9cm) length, 1800ml vol., 5/cs SB979

Nylon

10mm, 3" (7.6cm) diameter,
6" (15.2cm) length, 240ml vol., 5/cs SB1036

12mm, 7.5" (19.1cm) diameter,
9" (22.9cm) length, 1800ml vol., 5/cs SB1079

Independent Memory Wire Bag

Polymer

10mm, 3" (7.6cm) diameter,
6" (15.2cm) length, 200ml vol., 10/cs SB836

10mm, 5" (12.7cm) diameter,
7" (17.7cm) length, 750ml vol., 10/cs SB857



ACCESS

SMOKE

ENERGY

INSTRUMENTS

Specialty Products



PCD10

Puncture Closure Device (Trocar Wound Closure)

10mm, single-use, sterile,
Cannula 10-12mm, 10/case

PCD-10



CD801

Kittner Blunt Dissectors

Single tip Kittner, 5mm x 40cm, single
use, sterile, 5/cs

CD801



CD950

Aspiration Needle

Aspiration Injection Needle, 5mm x
40cm, 16GA, 5/cs

CD950



ACCESS

SMOKE

ENERGY

INSTRUMENTS



**ADVANCED SURGICAL
PRODUCT CATALOG**

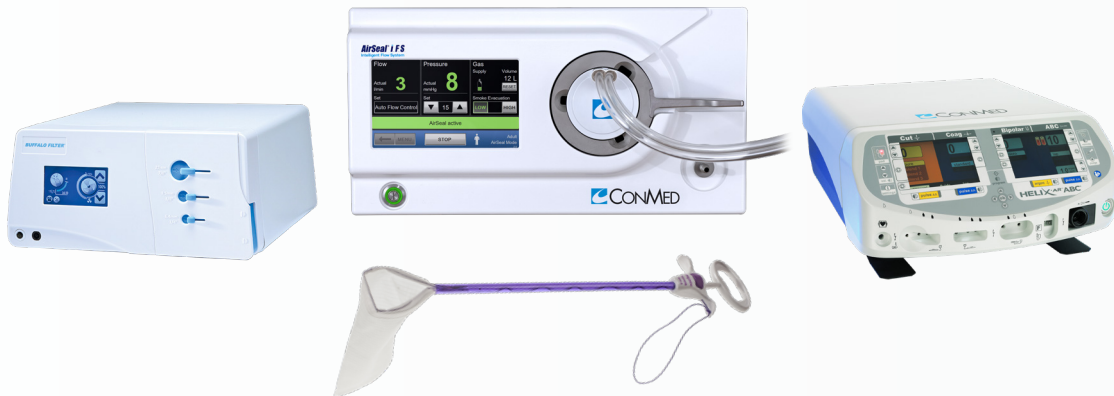

Some devices may not be available for sale in all regions.